



SUNSET  
*club house*

# Manual do Proprietário



LOCALIZAÇÃO DE UNIDADES

RUA NEWTON STILAC LEAL

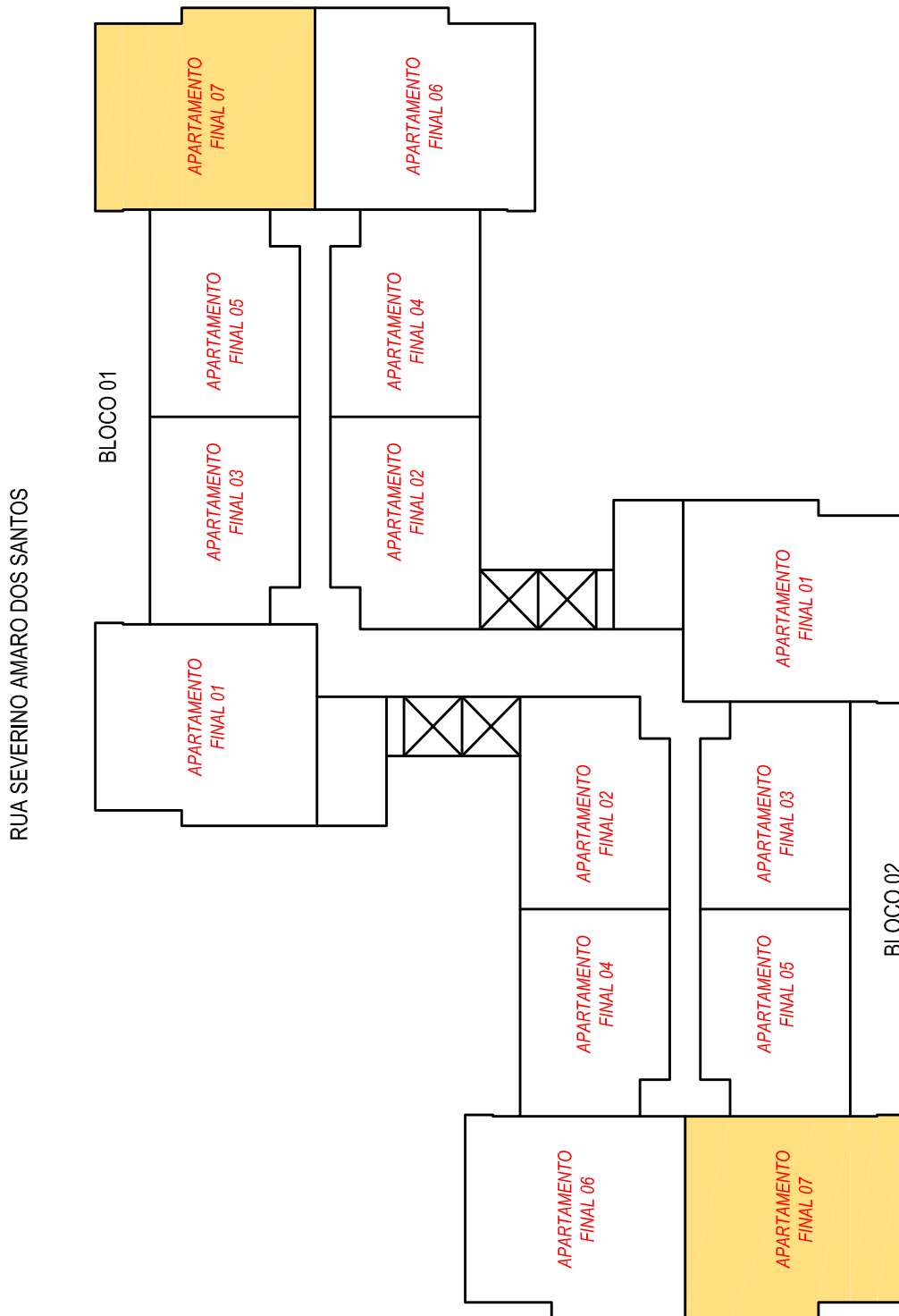

RUA DR. BENJAMIN ANDERSON STAUFFER



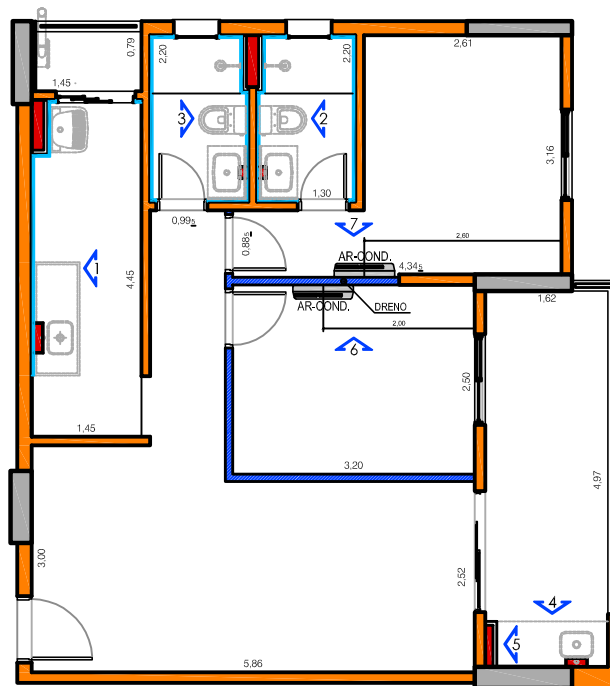

APARTAMENTO 2 DORMITÓRIOS  
FINAL 07



PLANTA ARQUITETÔNICA

LEGENDA

---

	PAREDE DE ALVENARIA
	PAREDE COM PONTOS DE RISCO
	PAREDE DE DRYWALL
	REVESTIMENTO CERÂMICO

APARTAMENTO 2 DORMITÓRIOS  
FINAL 07

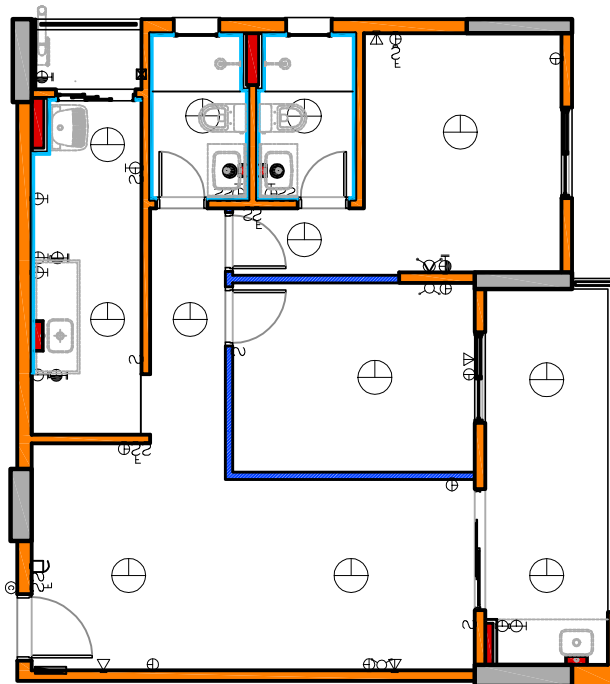

PLANTA ELÉTRICA

LEGENDA	
TOMADA BAIXA 127V - H=0,30M	PONTO ANTENA TV - H=1,10M
TOMADA MÉDIA 127V - H=1,10M.	PONTO ANTENA TV - H=1,95M
TOMADA ALTA 127V - H=1,95M	PONTO DE ILUMINAÇÃO
TOMADA BAIXA 220V - H=0,30M.	PONTO DE ILUMINAÇÃO
INTERRUPTOR - H=1,10M.	PONTO PARA AR EM CX. 4X2" .
PONTO TELEFONE - H=0,30M	QUADRO DISTRIBUIÇÃO
PONTO INTERFONE - H=1,30M	CAMPAINHA
PONTO ANTENA TV - H=0,30M	ACIONADOR CAMPAINHA - H=1,10M.



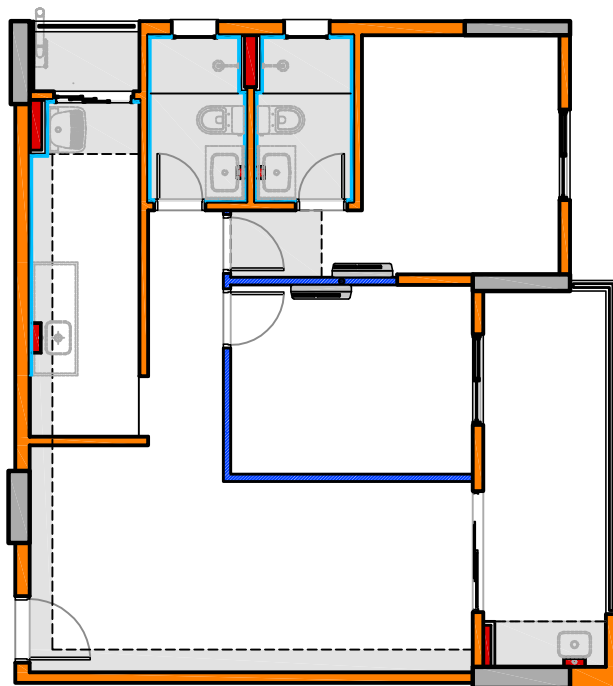

APARTAMENTO 2 DORMITÓRIOS  
FINAL 07



PLANTA GESSO

LEGENDA

---

	PAREDE DE ALVENARIA
	PAREDE COM PONTOS DE RISCO
	PAREDE DE DRYWALL
	REVESTIMENTO CERÂMICO

APARTAMENTO 2 DORMITÓRIOS  
FINAL 07

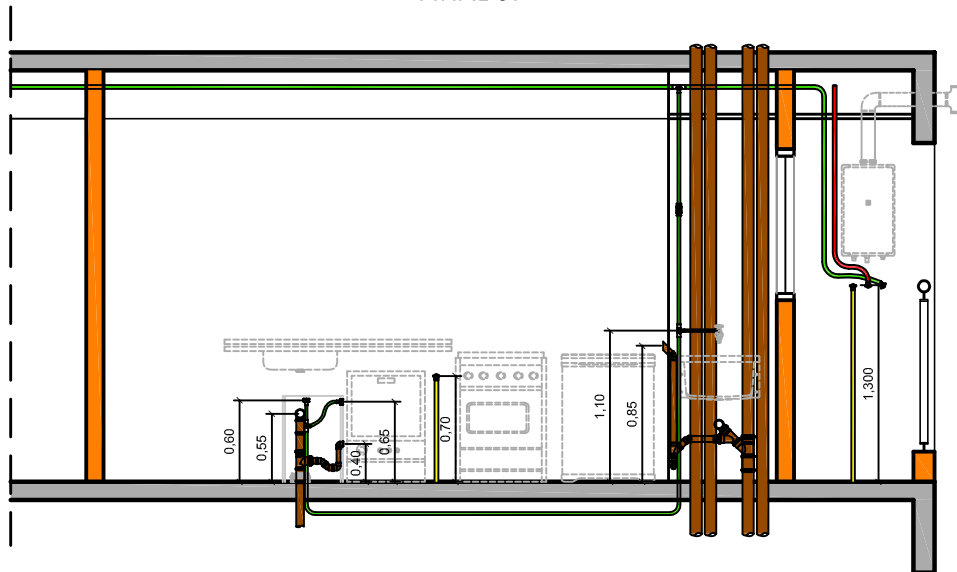

ELEVAÇÃO 01

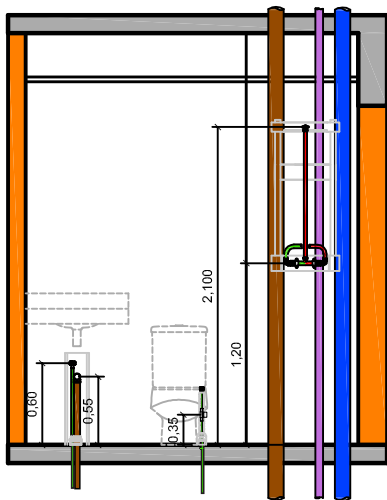



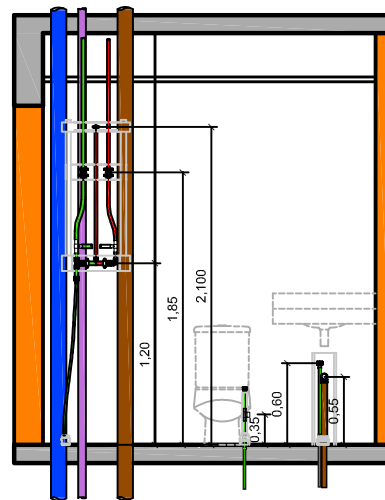



ELEVAÇÃO 02



ELEVAÇÃO 03

LEGENDA

	TUBULAÇÃO DE ÁGUA PLUVIAL
	TUBULAÇÃO DE VENTILAÇÃO
	TUBULAÇÃO DE ÁGUA FRIA
	TUBULAÇÃO DE ÁGUA QUENTE
	TUBULAÇÃO DE ESGOTO
	TUBULAÇÃO DE GÁS

APARTAMENTO 2 DORMITÓRIOS  
FINAL 07

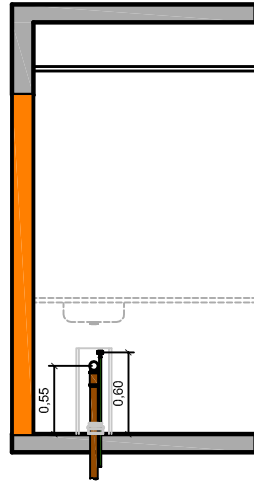

ELEVAÇÃO 04

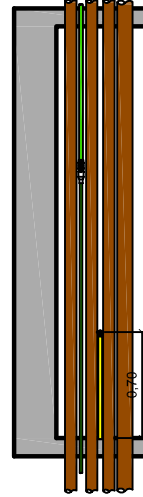

ELEVAÇÃO 05

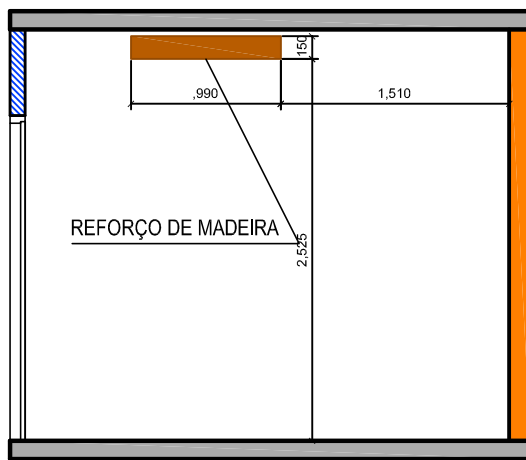

ELEVAÇÃO 06

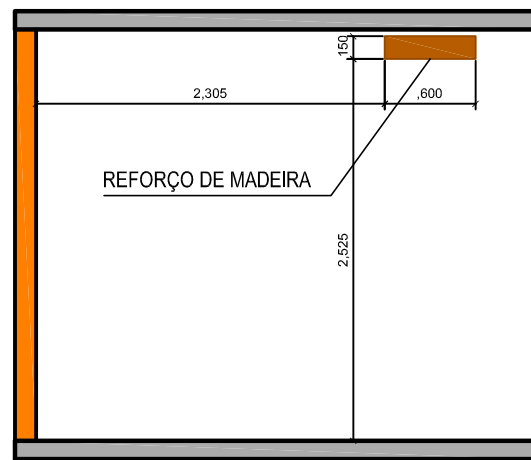

ELEVAÇÃO 07

LEGENDA

	TUBULAÇÃO DE ÁGUA PLUVIAL
	TUBULAÇÃO DE VENTILAÇÃO
	TUBULAÇÃO DE ÁGUA FRIA
	TUBULAÇÃO DE ÁGUA QUENTE
	TUBULAÇÃO DE ESGOTO
	TUBULAÇÃO DE GÁS

APARTAMENTO 2 DORMITÓRIOS  
FINAL 07

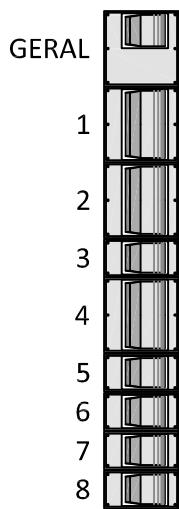

QUADRO DE DISJUNTORES			
CIRCUITO	CAPACIDADE	VOLTAGEM	FINALIDADE
GERAL	63A	220v	GERAL BIFÁSICO
1	25A	127v	AR-CONDICIONADO
2	25A	127v	AR-CONDICIONADO
3	16A	127v	ILUMINAÇÃO
4	20A	220v	MÁQUINA DE LAVAR LOUÇAS
5	20A	127v	FORNO MICROONDAS
6	20A	127v	TOMADAS COZINHA
7	20A	220v	TOMADAS ÁREA DE SERVIÇO
8	20A	127v	TOMADAS USO GERAL

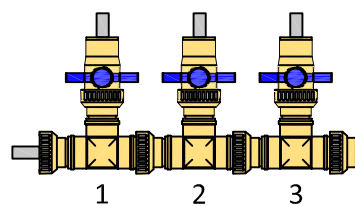

LEGENDA

