

FINAL DOS APARTAMENTOS

APARTAMENTO 2 DORMITÓRIOS
FINAL 04

RUA JOSÉ ANTONIO BRAGA

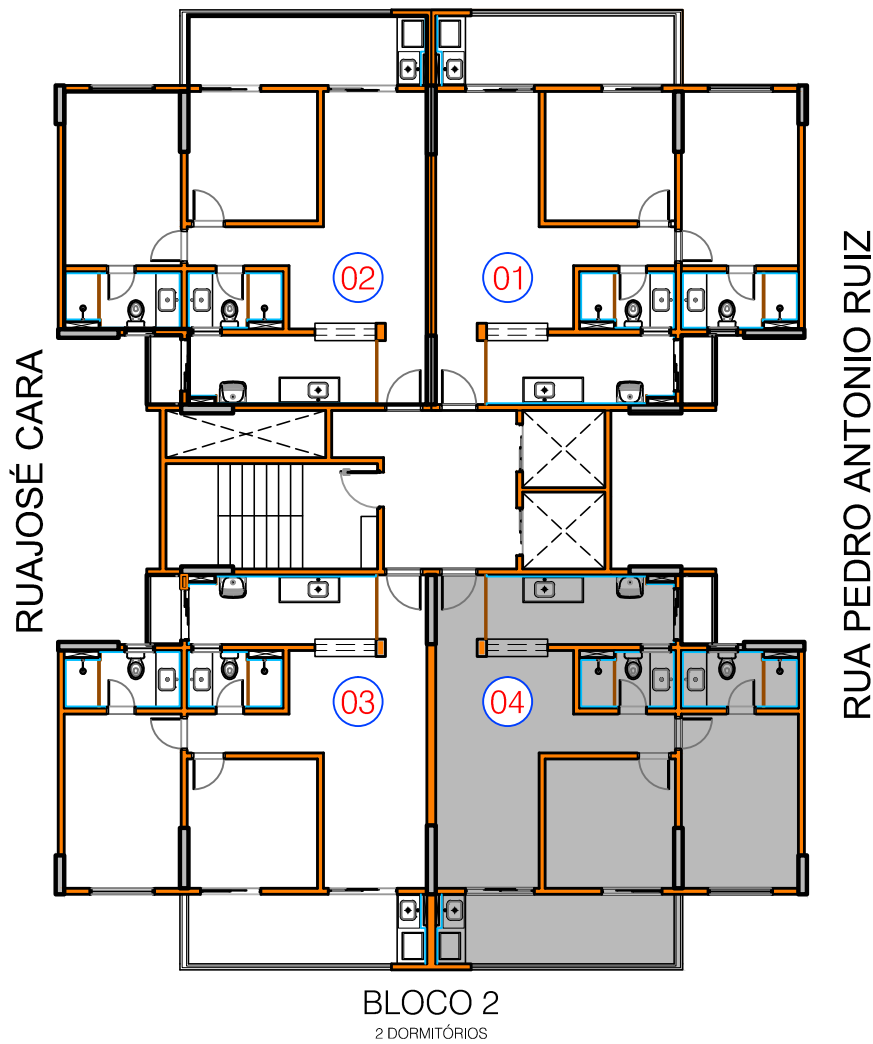



PLANTA ARQUITETÔNICA

APARTAMENTO 2 DORMITÓRIOS
FINAL 04

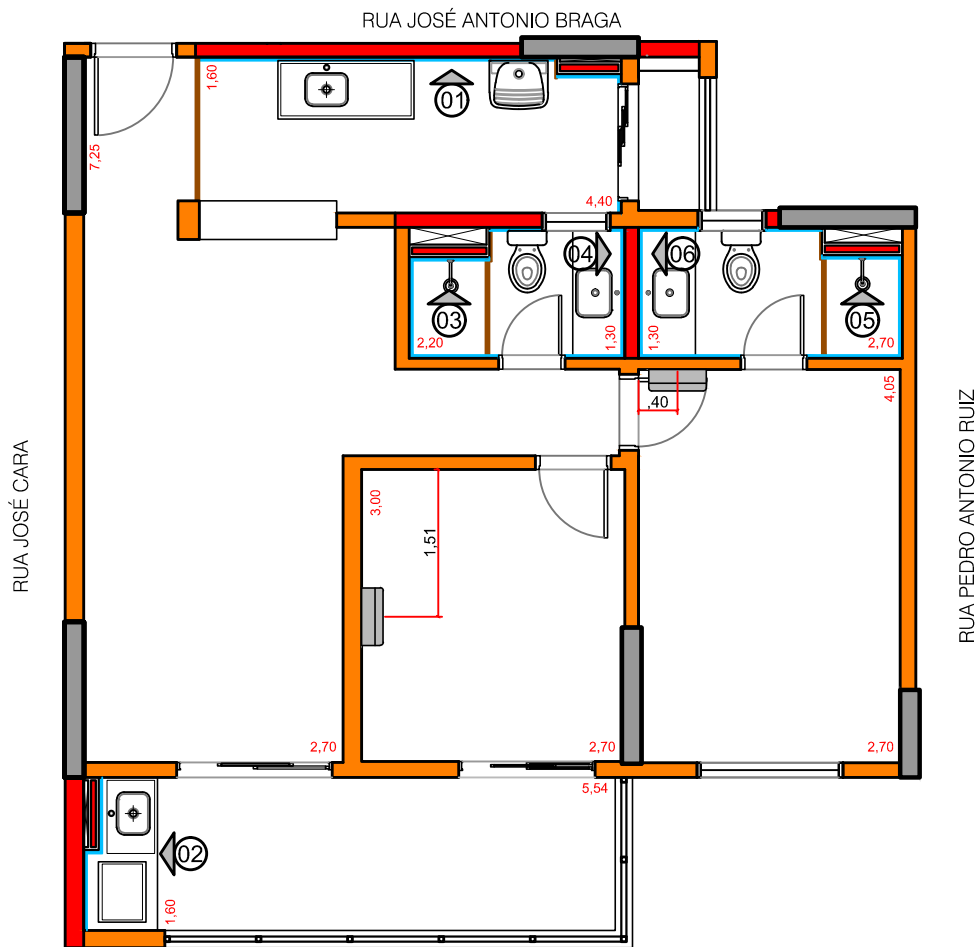

PLANTA - FINAL 04
SEM ESCALA

LEGENDA DE PAREDES	
	PAREDE DE ALVENARIA
	PAREDE COM PONTOS HIDRÁULICOS

LEGENDA DE PAREDES	
	TUBULAÇÃO DE ÁGUA PLUVIAL
	TUBULAÇÃO VENTILAÇÃO
	TUBULAÇÃO DE ÁGUA FRIA
	TUBULAÇÃO DE ÁGUA QUENTE
	TUBULAÇÃO DE ESGOTO
	TUBULAÇÃO DE GÁS





PLANTA ELÉTRICA

APARTAMENTO 2 DORMITÓRIOS
FINAL 04

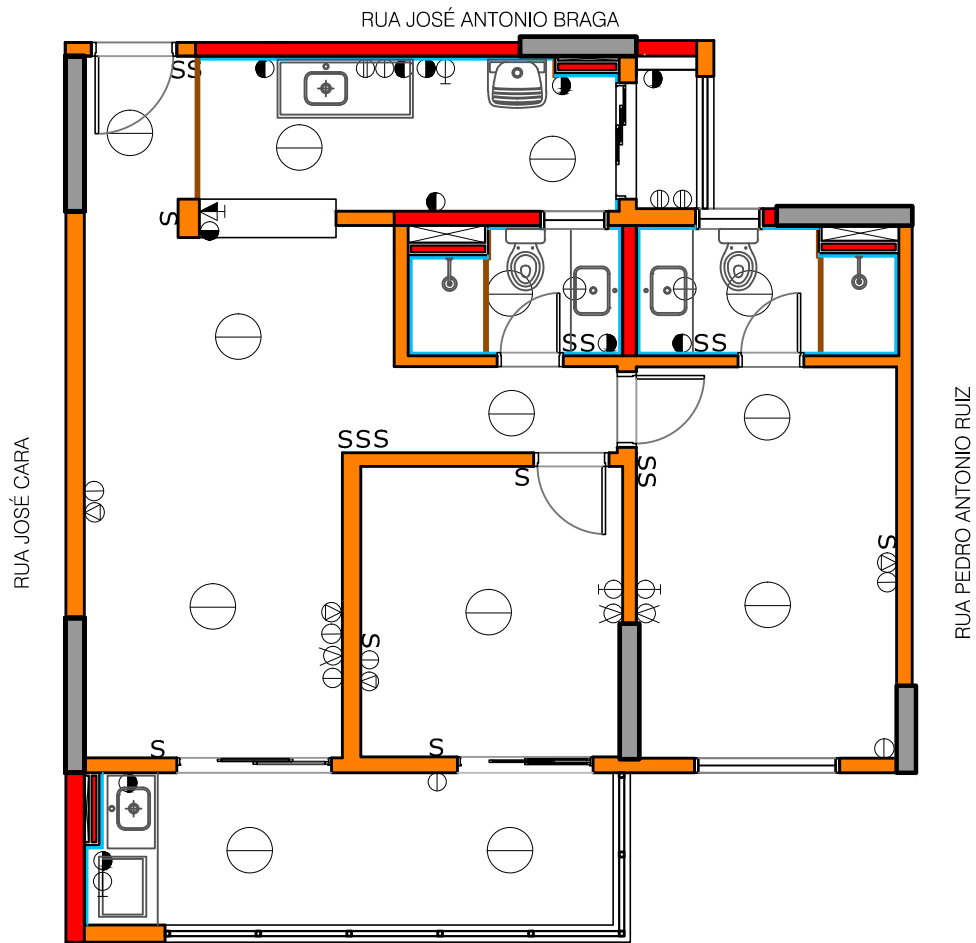

PLANTA - FINAL 04
SEM ESCALA

LEGENDA PONTOS ELÉTRICOS			
	ILUMINAÇÃO		ANTENA DE TV - BAIXO / ALTO
	TOMADA 127 V - BAIXO / MÉDIO / ALTO		TELEFONE
	TOMADA 220 V - BAIXO / ALTO		INTERFONE
	QUADRO DE LUZ		CAMPAINHA SONORA
	INTERRUPTOR		





QUADRO DE DISJUNTORES

APARTAMENTO 2 DORMITÓRIOS

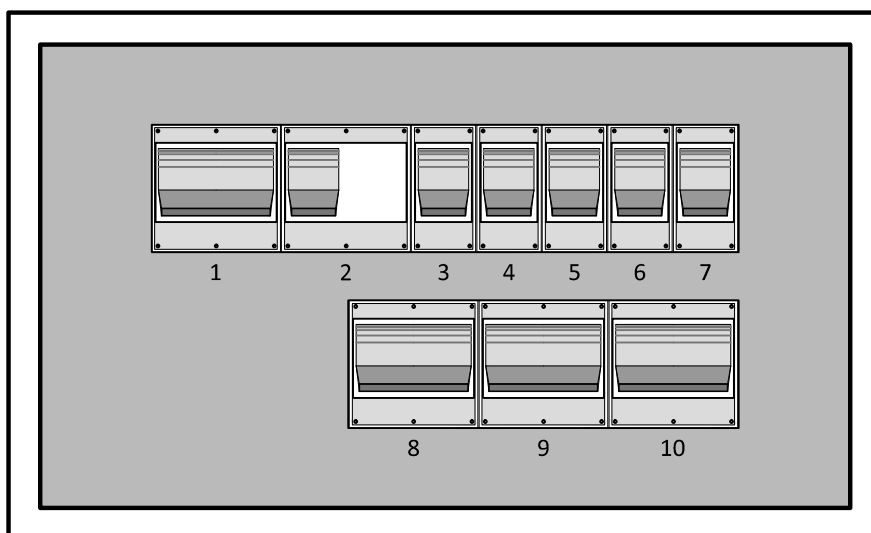
FINAL 04

QUADRO DE DISJUNTORES			
CIRCUITO	CAPACIDADE	VOLTAGEM	FINALIDADE
1	63A	220V	GERAL BIFÁSICO
2	63A	220V	INT. RESIDUAL BIFÁSICO
3	20A	127V	ILUMINAÇÃO E TOMADAS DOS DORMITÓRIOS, BANHEIRO E SUÍTE
4	20A	127V	ILUMINAÇÃO E TOMADAS DA SACADA E SALA
5	20A	127V	ILUMINAÇÃO E TOMADAS DA COZINHA E ÁREA DE SERVIÇO
6	20A	127V	TOMADAS COZINHA
7	20A	127V	MÁQUINA DE LAVAR ROUPA
8	25A	220V	MÁQUINA DE LAVAR LOUÇA
9	25A	220V	AR CONDICIONADO
10	25A	220V	AR CONDICIONADO





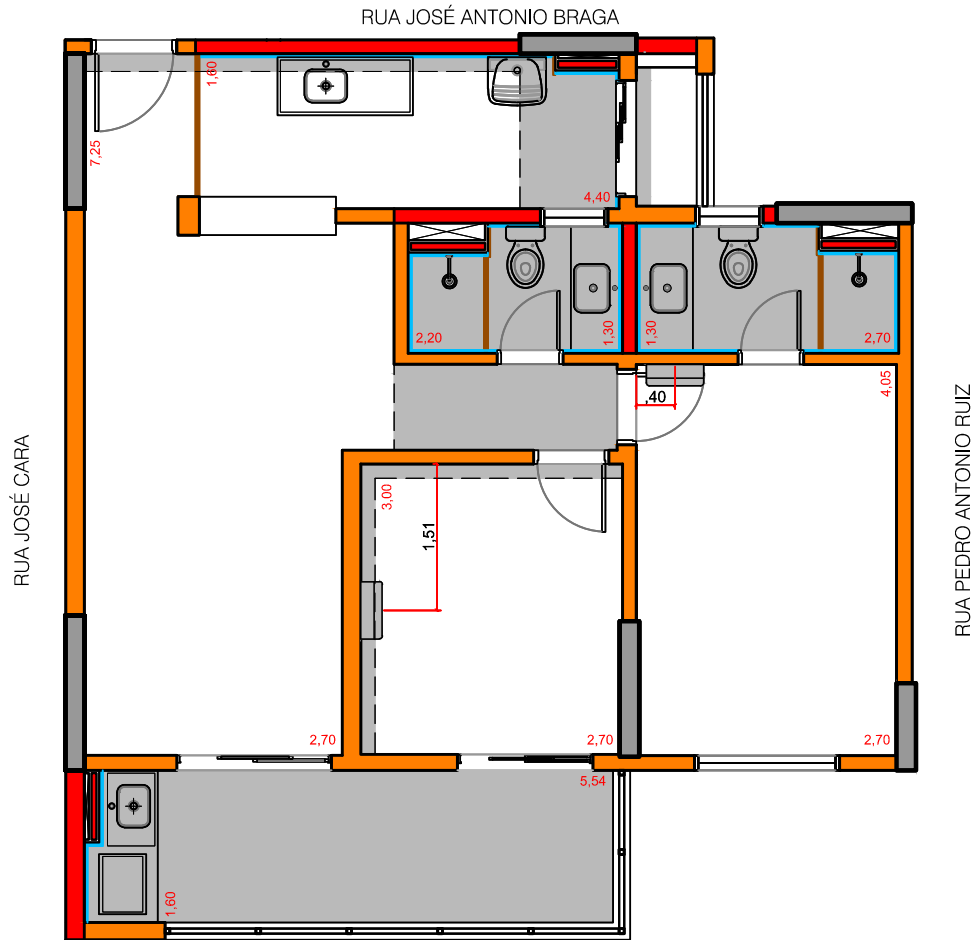

PLANTA FORRO DE GESSO

APARTAMENTO 2 DORMITÓRIOS
FINAL 04



PLANTA - FINAL 04

SEM ESCALA

LEGENDA DE PAREDES	
	PAREDE DE ALVENARIA
	PAREDE COM PONTOS HIDRÁULICOS

LEGENDA DE PAREDES	
	TUBULAÇÃO DE ÁGUA PLUVIAL
	TUBULAÇÃO VENTILAÇÃO
	TUBULAÇÃO DE ÁGUA FRIA
	TUBULAÇÃO DE ÁGUA QUENTE
	TUBULAÇÃO DE ESGOTO
	TUBULAÇÃO DE GÁS





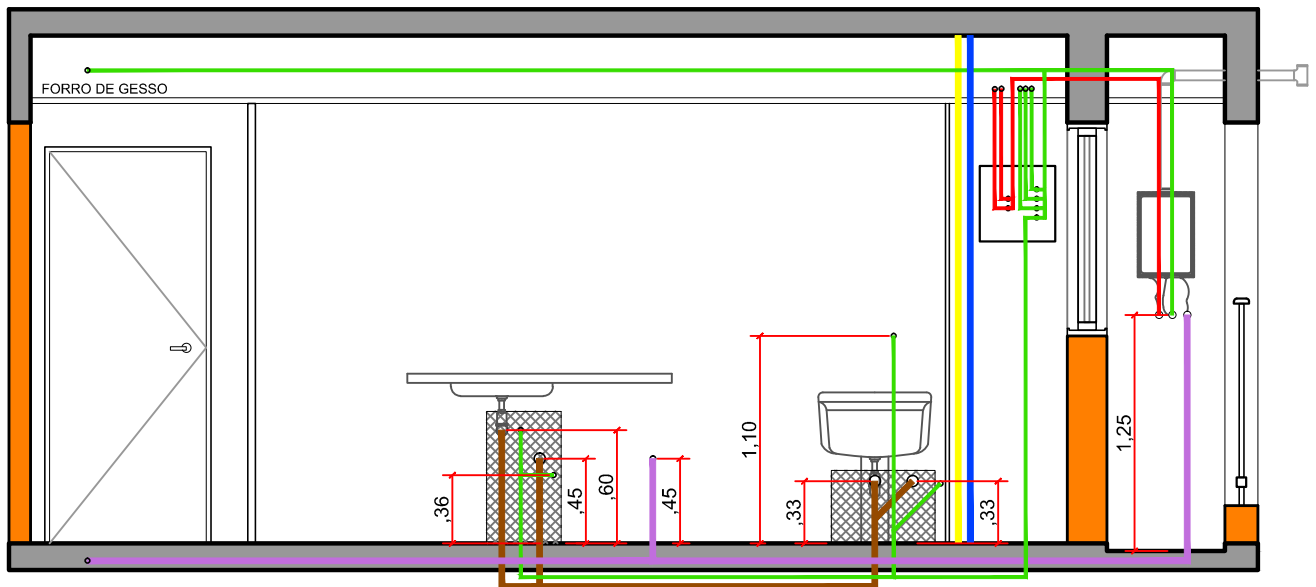

ELEVAÇÃO PRUMADA HIDRÁULICA

APARTAMENTO 2 DORMITÓRIOS
FINAL 04



ELEVAÇÃO 01

SEM ESCALA

LEGENDA DE PAREDES	
	PAREDE DE ALVENARIA
	PAREDE COM PONTOS HIDRÁULICOS

LEGENDA DE PAREDES	
	TUBULAÇÃO DE ÁGUA PLUVIAL
	TUBULAÇÃO VENTILAÇÃO
	TUBULAÇÃO DE ÁGUA FRIA
	TUBULAÇÃO DE ÁGUA QUENTE
	TUBULAÇÃO DE ESGOTO
	TUBULAÇÃO DE GÁS





ELEVAÇÃO PRUMADA HIDRÁULICA

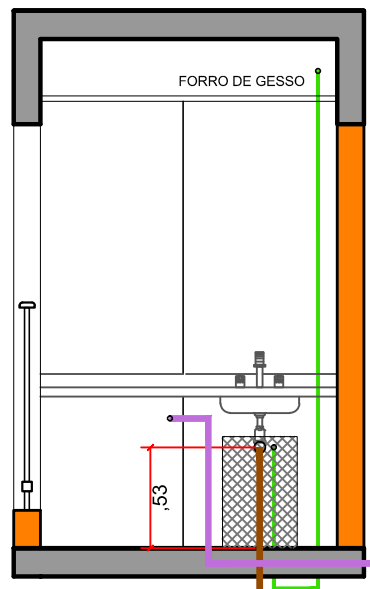

APARTAMENTO 2 DORMITÓRIOS
FINAL 04









ELEVÇÃO 02

SEM ESCALA

LEGENDA DE PAREDES

-  PAREDE DE ALVENARIA
-  PAREDE COM PONTOS HIDRÁULICOS

LEGENDA DE PAREDES

-  TUBULAÇÃO DE ÁGUA PLUVIAL
-  TUBULAÇÃO VENTILAÇÃO
-  TUBULAÇÃO DE ÁGUA FRIA
-  TUBULAÇÃO DE ÁGUA QUENTE
-  TUBULAÇÃO DE ESGOTO
-  TUBULAÇÃO DE GÁS





ELEVAÇÃO PRUMADA HIDRÁULICA

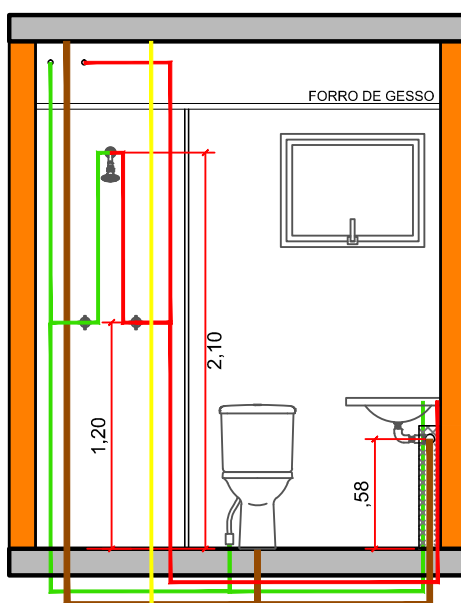

APARTAMENTO 2 DORMITÓRIOS **FINAL 04**









ELEVAÇÃO 03

SEM ESCALA

LEGENDA DE PAREDES

-  PAREDE DE ALVENARIA
-  PAREDE COM PONTOS HIDRÁULICOS

LEGENDA DE PAREDES

-  TUBULAÇÃO DE ÁGUA PLUVIAL
-  TUBULAÇÃO VENTILAÇÃO
-  TUBULAÇÃO DE ÁGUA FRIA
-  TUBULAÇÃO DE ÁGUA QUENTE
-  TUBULAÇÃO DE ESGOTO
-  TUBULAÇÃO DE GÁS







ELEVAÇÃO PRUMADA HIDRÁULICA

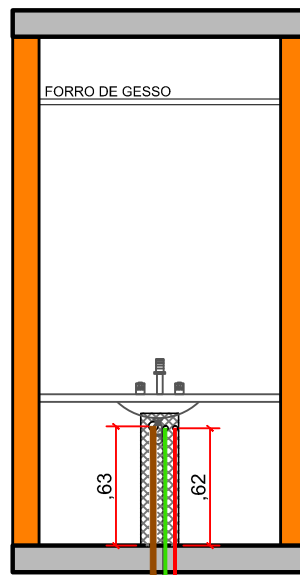

APARTAMENTO 2 DORMITÓRIOS
FINAL 04



ELEVAÇÃO 04

SEM ESCALA

LEGENDA DE PAREDES	
	PAREDE DE ALVENARIA
	PAREDE COM PONTOS HIDRÁULICOS

LEGENDA DE PAREDES	
	TUBULAÇÃO DE ÁGUA PLUVIAL
	TUBULAÇÃO VENTILAÇÃO
	TUBULAÇÃO DE ÁGUA FRIA
	TUBULAÇÃO DE ÁGUA QUENTE
	TUBULAÇÃO DE ESGOTO
	TUBULAÇÃO DE GÁS





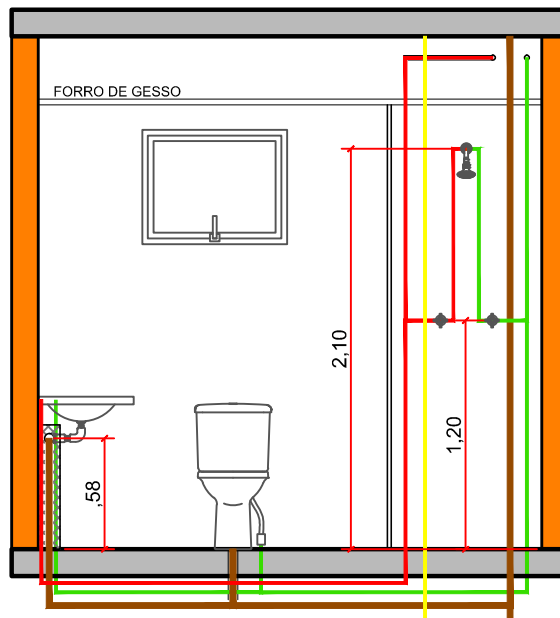

ELEVAÇÃO PRUMADA HIDRÁULICA

APARTAMENTO 2 DORMITÓRIOS
FINAL 04



ELEVAÇÃO 05

SEM ESCALA

LEGENDA DE PAREDES	
	PAREDE DE ALVENARIA
	PAREDE COM PONTOS HIDRÁULICOS

LEGENDA DE PAREDES	
	TUBULAÇÃO DE ÁGUA PLUVIAL
	TUBULAÇÃO VENTILAÇÃO
	TUBULAÇÃO DE ÁGUA FRIA
	TUBULAÇÃO DE ÁGUA QUENTE
	TUBULAÇÃO DE ESGOTO
	TUBULAÇÃO DE GÁS





ELEVAÇÃO PRUMADA HIDRÁULICA

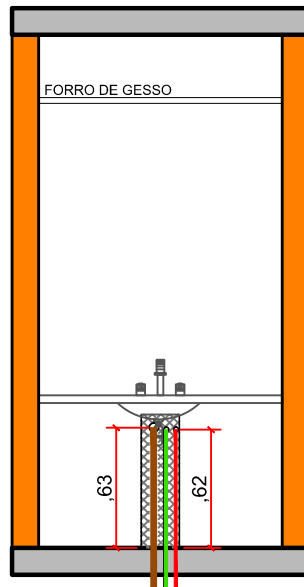

APARTAMENTO 2 DORMITÓRIOS
FINAL 04









ELEVAÇÃO 06

SEM ESCALA

LEGENDA DE PAREDES

-  PAREDE DE ALVENARIA
-  PAREDE COM PONTOS HIDRÁULICOS

LEGENDA DE PAREDES

-  TUBULAÇÃO DE ÁGUA PLUVIAL
-  TUBULAÇÃO VENTILAÇÃO
-  TUBULAÇÃO DE ÁGUA FRIA
-  TUBULAÇÃO DE ÁGUA QUENTE
-  TUBULAÇÃO DE ESGOTO
-  TUBULAÇÃO DE GÁS





MANIFOLD ÁGUA FRIA E ÁGUA QUENTE
ÁREA DE SERVIÇO

APARTAMENTO 2 DORMITÓRIOS
FINAL 04

