

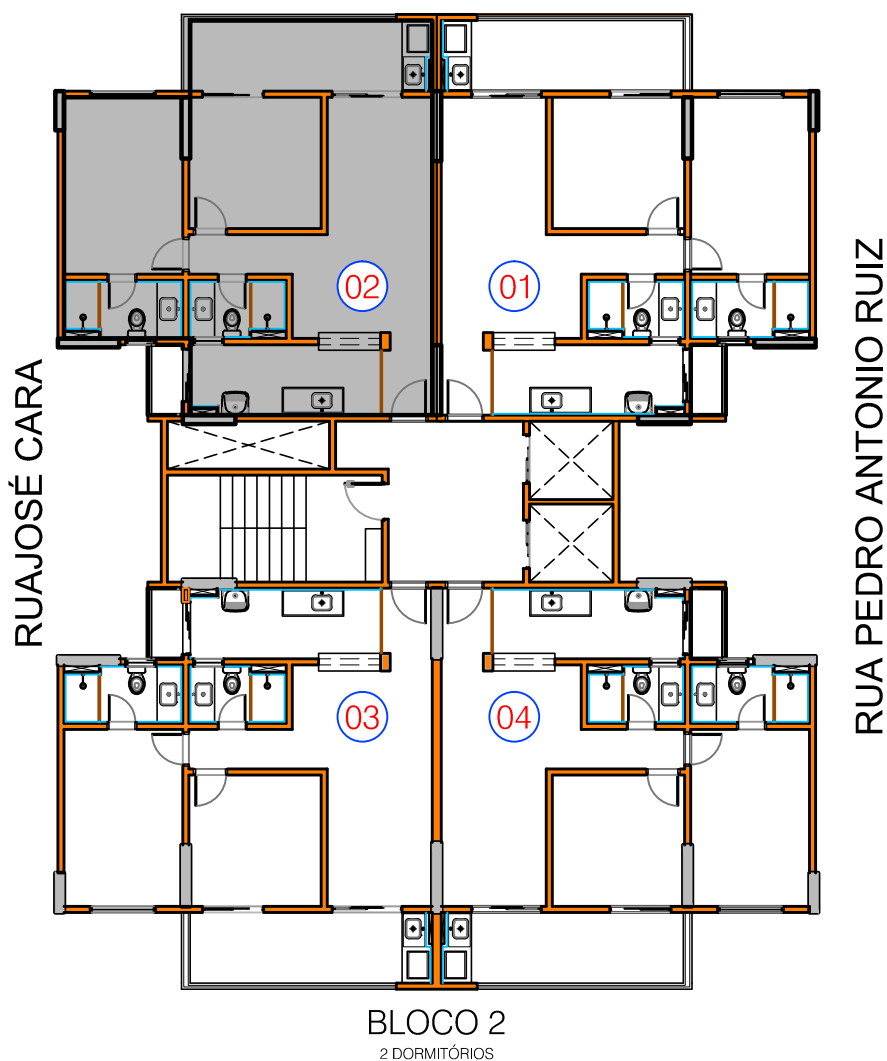

FINAL DOS APARTAMENTOS

APARTAMENTO 2 DORMITÓRIOS  
**FINAL 02**

RUA JOSÉ ANTONIO BRAGA





PLANTA ARQUITETÔNICA

APARTAMENTO 2 DORMITÓRIOS  
**FINAL 02**

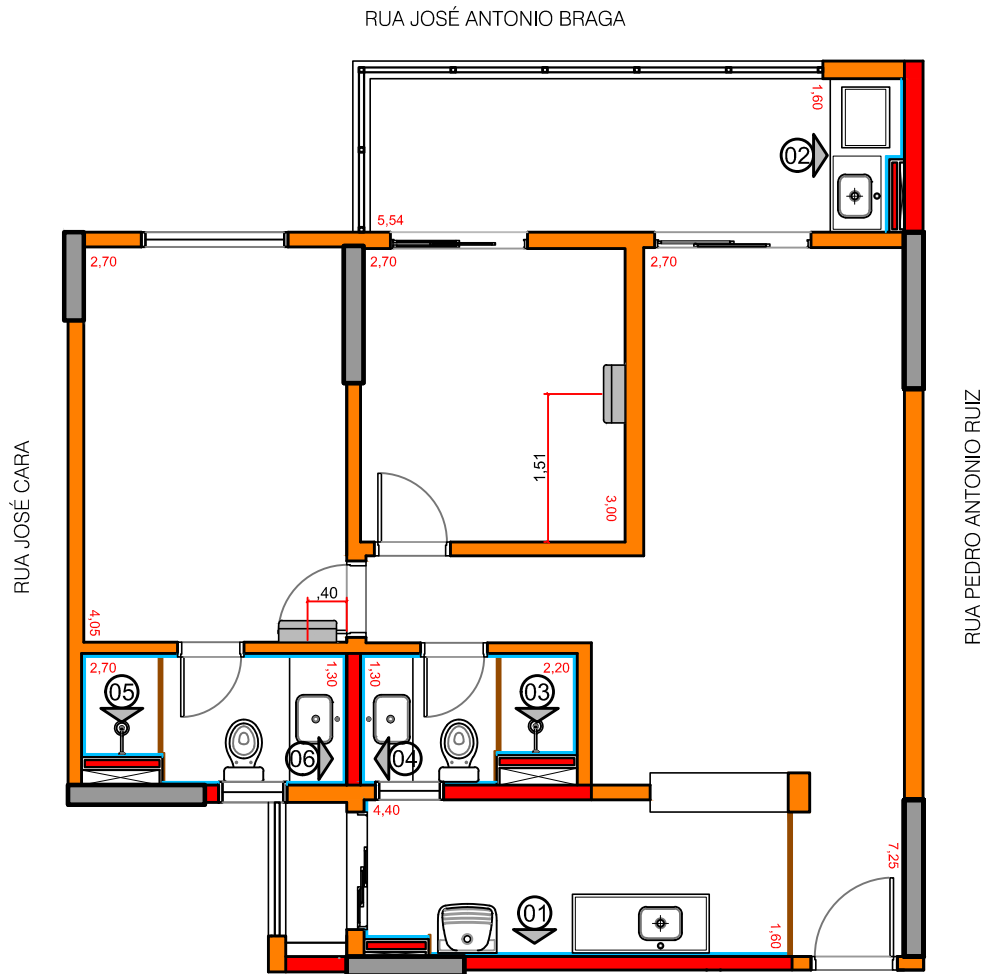

**PLANTA - FINAL 02**  
SEM ESCALA

LEGENDA DE PAREDES	
	PAREDE DE ALVENARIA
	PAREDE COM PONTOS HIDRÁULICOS

LEGENDA DE PAREDES	
	TUBULAÇÃO DE ÁGUA PLUVIAL
	TUBULAÇÃO VENTILAÇÃO
	TUBULAÇÃO DE ÁGUA FRIA
	TUBULAÇÃO DE ÁGUA QUENTE
	TUBULAÇÃO DE ESGOTO
	TUBULAÇÃO DE GÁS





PLANTA ELÉTRICA

APARTAMENTO 2 DORMITÓRIOS  
**FINAL 02**

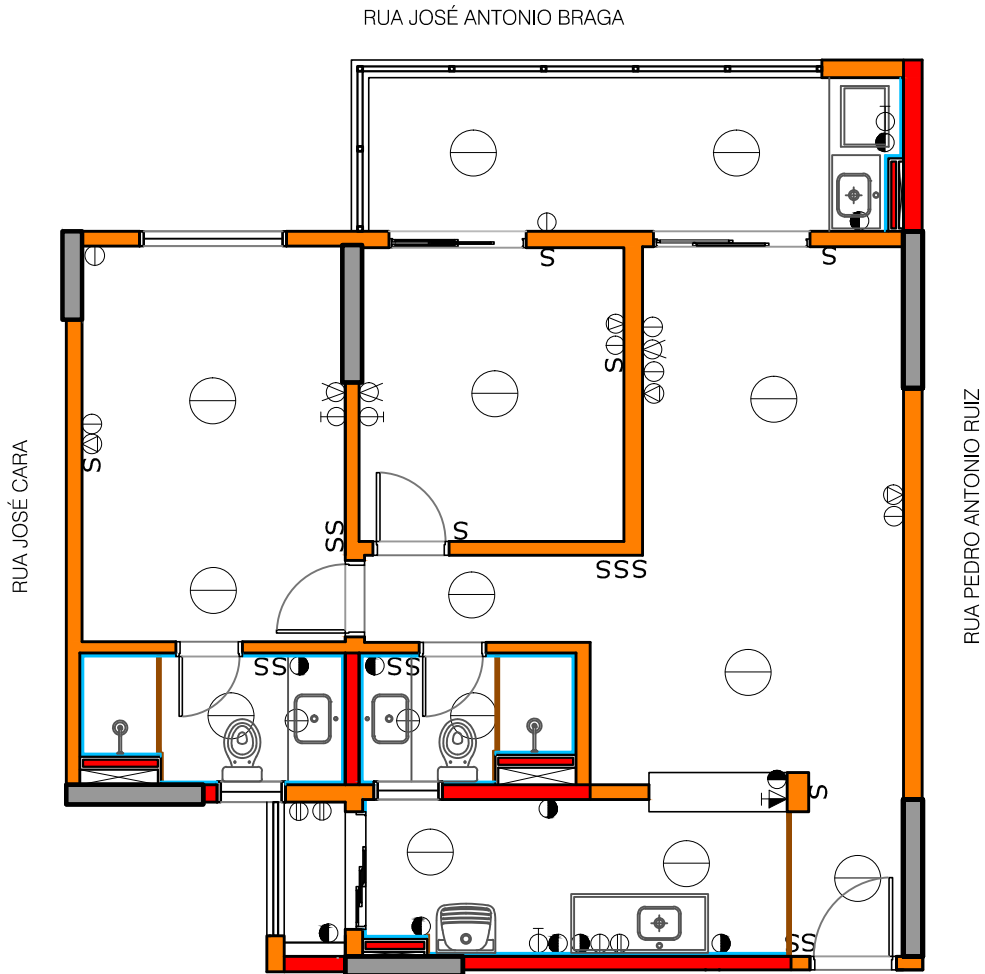

**PLANTA - FINAL 02**  
SEM ESCALA

LEGENDA PONTOS ELÉTRICOS	
	ILUMINAÇÃO
	TOMADA 127 V - BAIXO / MÉDIO / ALTO
	TOMADA 220 V - BAIXO / ALTO
	QUADRO DE LUZ
	INTERRUPTOR
	ANTENA DE TV - BAIXO / ALTO
	TELEFONE
	INTERFONE
	CAMPAINHA SONORA



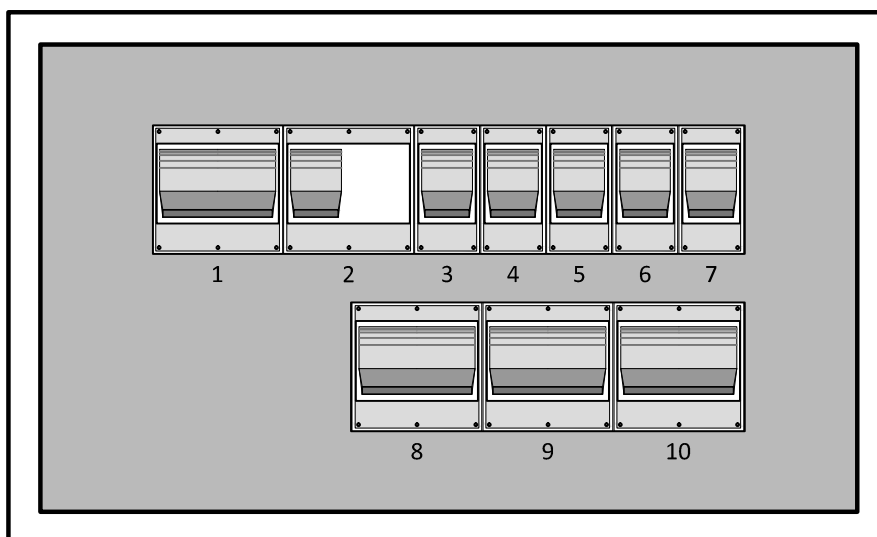

## QUADRO DE DISJUNTORES

APARTAMENTO 2 DORMITÓRIOS  
**FINAL 02**

QUADRO DE DISJUNTORES			
CIRCUITO	CAPACIDADE	VOLTAGEM	FINALIDADE
1	63A	220v	GERAL BIFÁSICO
2	63A	220v	INT. RESIDUAL BIFÁSICO
3	20A	127v	ILUMINAÇÃO E TOMADAS DOS DORMITÓRIOS, BANHEIRO E SUÍTE
4	20A	127v	ILUMINAÇÃO E TOMADAS DA SACADA E SALA
5	20A	127v	ILUMINAÇÃO E TOMADAS DA COZINHA E ÁREA DE SERVIÇO
6	20A	127v	TOMADAS COZINHA
7	20A	127v	MÁQUINA DE LAVAR ROUPA
8	25A	220v	MÁQUINA DE LAVAR LOUÇA
9	25A	220v	AR CONDICIONADO
10	25A	220v	AR CONDICIONADO





PLANTA FORRO DE GESSO

APARTAMENTO 2 DORMITÓRIOS  
**FINAL 02**

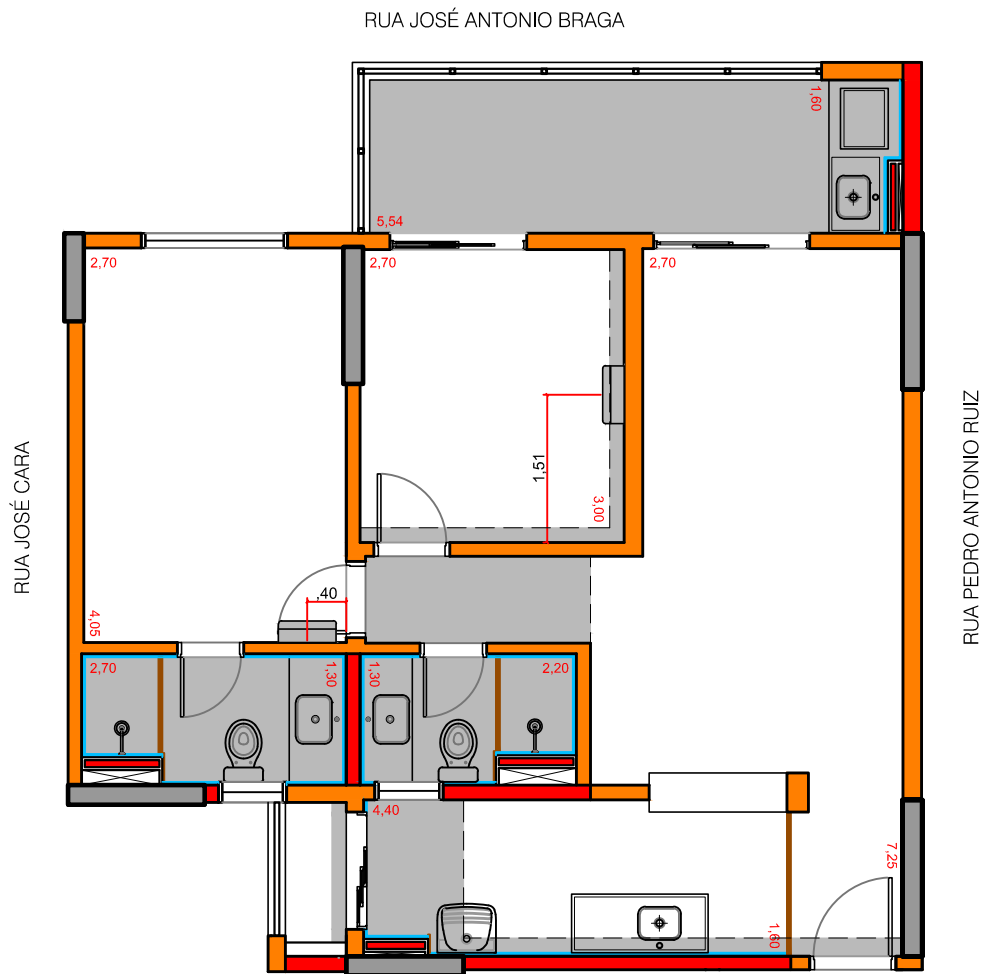

**PLANTA - FINAL 02**  
SEM ESCALA

LEGENDA DE PAREDES	
	PAREDE DE ALVENARIA
	PAREDE COM PONTOS HIDRÁULICOS

LEGENDA DE PAREDES	
	TUBULAÇÃO DE ÁGUA PLUVIAL
	TUBULAÇÃO VENTILAÇÃO
	TUBULAÇÃO DE ÁGUA FRIA
	TUBULAÇÃO DE ÁGUA QUENTE
	TUBULAÇÃO DE ESGOTO
	TUBULAÇÃO DE GÁS





ELEVAÇÃO PRUMADA HIDRÁULICA

APARTAMENTO 2 DORMITÓRIOS  
**FINAL 02**

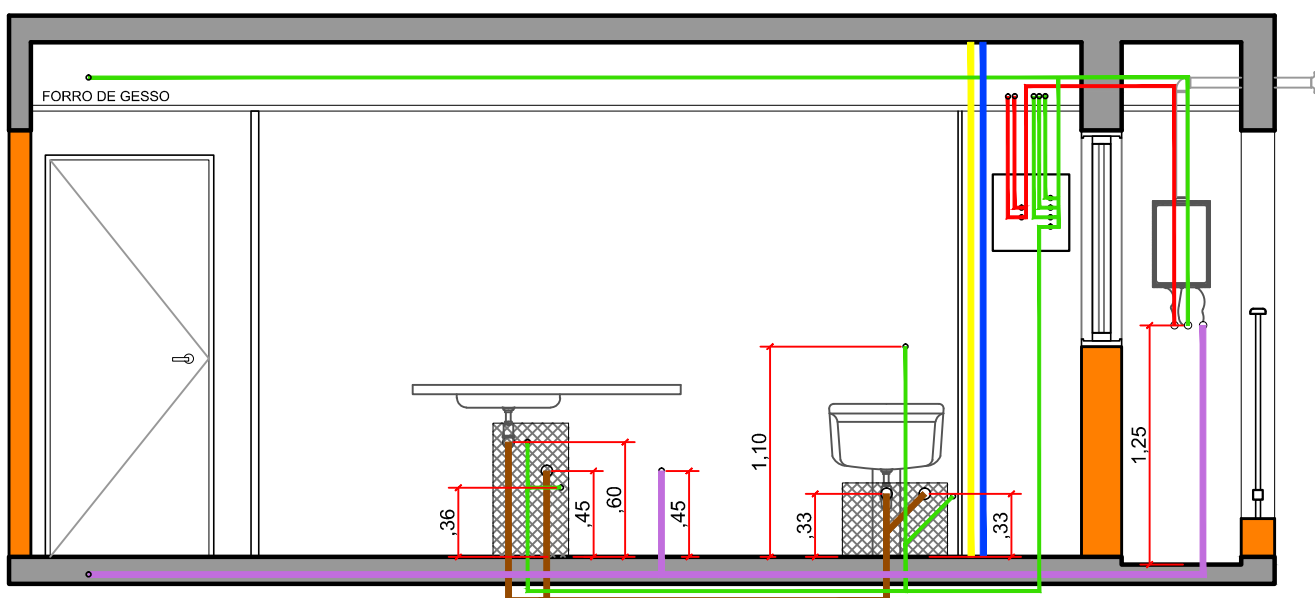

**ELEVAÇÃO 01**

SEM ESCALA

LEGENDA DE PAREDES	
	PAREDE DE ALVENARIA
	PAREDE COM PONTOS HIDRÁULICOS

LEGENDA DE PAREDES	
	TUBULAÇÃO DE ÁGUA PLUVIAL
	TUBULAÇÃO VENTILAÇÃO
	TUBULAÇÃO DE ÁGUA FRIA
	TUBULAÇÃO DE ÁGUA QUENTE
	TUBULAÇÃO DE ESGOTO
	TUBULAÇÃO DE GÁS





## ELEVAÇÃO PRUMADA HIDRÁULICA

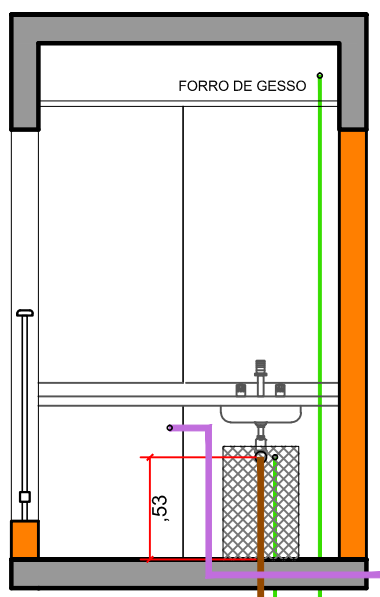

### APARTAMENTO 2 DORMITÓRIOS **FINAL 02**









**ELEVAÇÃO 02**

SEM ESCALA

#### LEGENDA DE PAREDES

-  PAREDE DE ALVENARIA
-  PAREDE COM PONTOS HIDRÁULICOS

#### LEGENDA DE PAREDES

-  TUBULAÇÃO DE ÁGUA PLUVIAL
-  TUBULAÇÃO VENTILAÇÃO
-  TUBULAÇÃO DE ÁGUA FRIA
-  TUBULAÇÃO DE ÁGUA QUENTE
-  TUBULAÇÃO DE ESGOTO
-  TUBULAÇÃO DE GÁS







ELEVAÇÃO PRUMADA HIDRÁULICA

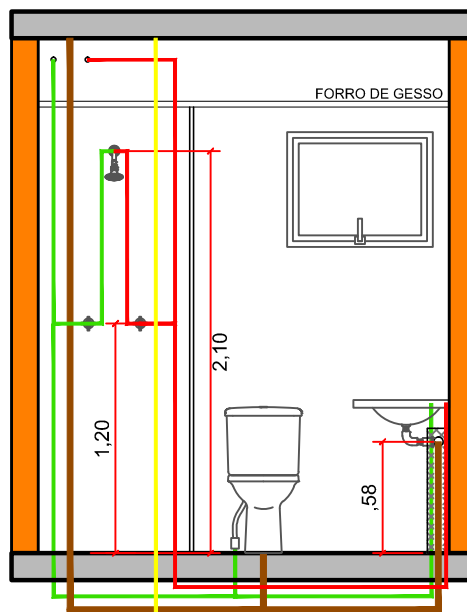



APARTAMENTO 2 DORMITÓRIOS  
**FINAL 02**



**ELEVAÇÃO 03**

SEM ESCALA

LEGENDA DE PAREDES	
	PAREDE DE ALVENARIA
	PAREDE COM PONTOS HIDRÁULICOS

LEGENDA DE PAREDES	
	TUBULAÇÃO DE ÁGUA PLUVIAL
	TUBULAÇÃO VENTILAÇÃO
	TUBULAÇÃO DE ÁGUA FRIA
	TUBULAÇÃO DE ÁGUA QUENTE
	TUBULAÇÃO DE ESGOTO
	TUBULAÇÃO DE GÁS







ELEVAÇÃO PRUMADA HIDRÁULICA

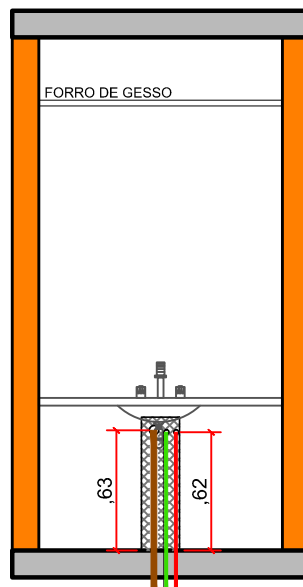



APARTAMENTO 2 DORMITÓRIOS  
**FINAL 02**



**ELEVAÇÃO 04**

SEM ESCALA

LEGENDA DE PAREDES	
	PAREDE DE ALVENARIA
	PAREDE COM PONTOS HIDRÁULICOS

LEGENDA DE PAREDES	
	TUBULAÇÃO DE ÁGUA PLUVIAL
	TUBULAÇÃO VENTILAÇÃO
	TUBULAÇÃO DE ÁGUA FRIA
	TUBULAÇÃO DE ÁGUA QUENTE
	TUBULAÇÃO DE ESGOTO
	TUBULAÇÃO DE GÁS





ELEVAÇÃO PRUMADA HIDRÁULICA

APARTAMENTO 2 DORMITÓRIOS  
**FINAL 02**

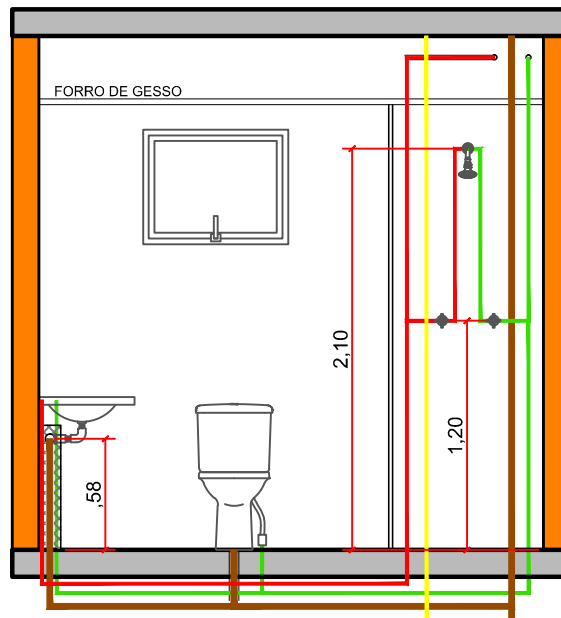

**ELEVAÇÃO 05**

SEM ESCALA

LEGENDA DE PAREDES

- PAREDE DE ALVENARIA
- PAREDE COM PONTOS HIDRÁULICOS

LEGENDA DE PAREDES

- TUBULAÇÃO DE ÁGUA PLUVIAL
- TUBULAÇÃO VENTILAÇÃO
- TUBULAÇÃO DE ÁGUA FRIA
- TUBULAÇÃO DE ÁGUA QUENTE
- TUBULAÇÃO DE ESGOTO
- TUBULAÇÃO DE GÁS







ELEVAÇÃO PRUMADA HIDRÁULICA

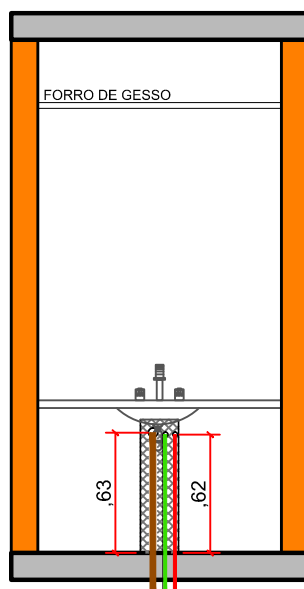





APARTAMENTO 2 DORMITÓRIOS  
**FINAL 02**



**ELEVAÇÃO 06**

SEM ESCALA

LEGENDA DE PAREDES	
	PAREDE DE ALVENARIA
	PAREDE COM PONTOS HIDRÁULICOS

LEGENDA DE PAREDES	
	TUBULAÇÃO DE ÁGUA PLUVIAL
	TUBULAÇÃO VENTILAÇÃO
	TUBULAÇÃO DE ÁGUA FRIA
	TUBULAÇÃO DE ÁGUA QUENTE
	TUBULAÇÃO DE ESGOTO
	TUBULAÇÃO DE GÁS





MANIFOLD ÁGUA FRIA E ÁGUA QUENTE  
ÁREA DE SERVIÇO

APARTAMENTO 2 DORMITÓRIOS  
**FINAL 02**

